

MARINE EVACUATION SYSTEM (MES) 150 MAN THROW OVER BOARD SELF RIGHTING LIFERAFT ASSOCIATED WITH SMALL INFLATABLE SLIDE (SIS)

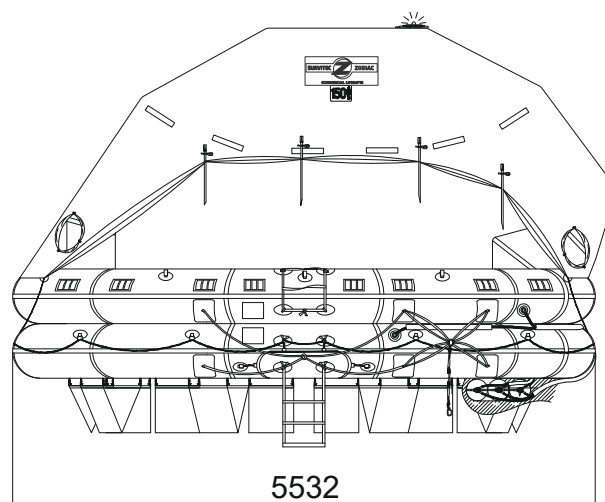
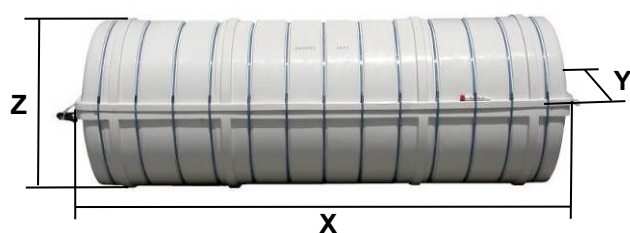
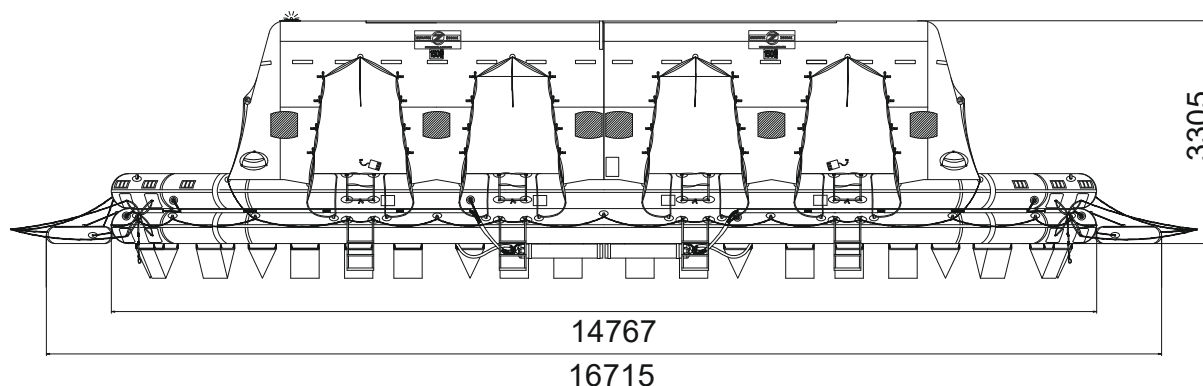
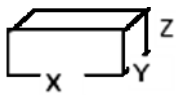

150 MAN MES SIS	A PACK			B PACK		
Container	N23			N23		
Dimensions	X: 3340 mm X: 10' 11,5"	Y: 1050 mm Y: 3' 5,34"	Z: 1035 mm Z: 3' 4,75"	X: 3340 mm X: 10' 11,5"	Y: 1050 mm Y: 3' 5,34"	Z: 1035 mm Z: 3' 4,75"
Liferaft Net Weight	995 kg / 2194 pounds			845 kg / 1863 pounds		
Max. height stowage	25 m / 83'			25 m / 83'		
Firing line length	35 m / 115'					
Inflation Cylinder	6 x 35 liter					
 Crate	X: 3450 mm X: 11' 3,83"	Y: 1150 mm Y: 3' 9,28"	Z: 1115 mm Z: 3' 7,9"	X: 3450 mm X: 11' 3,83"	Y: 1150 mm Y: 3' 9,28"	Z: 1115 mm Z: 3' 7,9"
	1030 kg / 2271 pounds			880 kg / 1941 pounds		
	4,424 m ³ / 156,21 cubic foot			4,424 m ³ / 156,21 cubic foot		
Towing force	2 knots			3 knots		
Without sea anchor	273 daN			481 daN		
With sea anchor	319 daN			568 daN		

150 TO SR MES SIS cont rond.doc

Issue: 6

Date: 11/07/2017

Dimensions and weight +/- 5%
SURVITEC SAS reserves the right to change specification without notice.
For installation, add minimum +10mm for clearance to dimensions of the container.

SIS (SMALL INFLATABLE SLIDE)

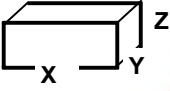

Slide in valise

SIS	1,70 m			2,20 m		
Valise						
Dimensions	X:670mm X:2' 2,38"	Y:300mm Y:11,82"	Z:260mm Z:10,24"	X:720mm X:2' 4,35"	Y:425mm Y:1' 4,74"	Z:295mm Z:11,62"
Slide net weight	15 kg / 34 pounds			19 kg / 42 pounds		
Max. evacuation height	1,70 m			2,20 m		
Firing line length	1,50 m			1,50 m		
Inflation cylinder	1 x 2,83 litres			1 x 4 litres		
 Crate	X:830mm X:2' 8,68"	Y:540mm Y:1' 9,26"	Z:330mm Z:1' 1"	X:830mm X:2' 8,68"	Y:540mm Y:1' 9,26"	Z:330mm Z:1' 1"
	17,6 kg / 39 pounds			21,6 kg / 48 pounds		
	0,148 m3 / 5,23 cubic foot			0,148 m3 / 5,23 cubic foot		

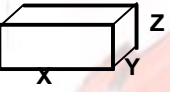
SIS	2,70 m			3,20 m		
Valise						
Dimensions	X:720mm X:2' 4,35"	Y:450mm Y:1' 5,72"	Z:295mm Z:11,62"	X:800mm X:2' 7,5"	Y:450mm Y:1' 5,72"	Z:295mm Z:11,62"
Slide net weight	27 kg / 60 pounds			28,5 kg / 63 pounds		
Max. evacuation height	2,70 m			3,20 m		
Firing line length	1,50 m			1,50 m		
Inflation cylinder	1 x 6 litres			1 x 6,7 litres		
 Crate	X:830mm X:2' 8,68"	Y:540mm Y:1' 9,26"	Z:330mm Z:1' 1"	X:830mm X:2' 8,68"	Y:540mm Y:1' 9,26"	Z:330mm Z:1' 1"
	29,6 kg / 66 pounds			31,1 kg / 69 pounds		
	0,148 m3 / 5,23 cubic foot			0,148 m3 / 5,23 cubic foot		

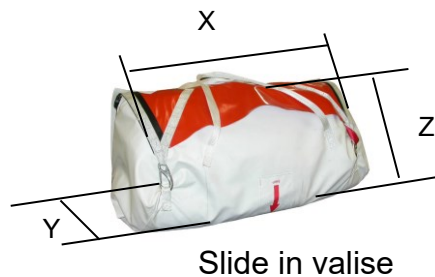

SIS	3,80 M		
	Valise		
Dimensions	X: 820 mm	Y: 450 mm	Z: 350 mm
	X: 2' 8,29"	Y: 1' 5,72"	Z: 1' 1,78"
Slide net weight	37 kg / 82 pounds		
Max. evacuation height	3,8 m / 13'		
Firing line length	1,5 m / 5'		
Inflation cylinder	1 x 10 liter		

 <p>Crate</p>	X: 920 mm	Y: 560 mm	Z: 370 mm
	X: 3' 0,23"	Y: 1' 10,05"	Z: 1' 2,57"
	40 kg / 89 pounds		
	0,191 m ³ / 6,74 cubic foot		

Approvals:	EC - TC
-------------------	----------------

150 TO SR MES SIS cont rond.doc	Issue: 6	Date: 11/07/2017
---------------------------------	----------	------------------

Dimensions and weight +/- 5%
 SURVITEC SAS reserves the right to change specification without notice.
 For installation, add minimum +10mm for clearance to dimensions of the container.